



**LAKE SHORE**  
ELECTRIC CORPORATION

## Quick Connection Cabinet (QCC)



### Installation / Operation / Maintenance Manual 400A thru 1200A Ratings, 480Vac Max

## WARNING!

WHEN WORKING ON EQUIPMENT OF THIS TYPE, EXTREME DANGER OF ELECTROCUTION EXISTS THAT MAY RESULT IN INJURY OR DEATH. DO NOT ATTEMPT ANY REPAIRS OR ADJUSTMENTS TO THIS EQUIPMENT WITHOUT FIRST TAKING THE APPROPRIATE PRECAUTIONS TO PREVENT PERSONAL INJURY AND EQUIPMENT DAMAGE.

DURING INSTALLATION AND USE OF THIS PRODUCT, COMPLY WITH THE NATIONAL ELECTRICAL CODE (NEC), FEDERAL, STATE AND LOCAL CODES, AND ALL OTHER APPLICABLE SAFETY CODES.

MAIN UTILITY POWER MUST BE OFF DURING INSTALLATION, WHEN PERFORMING EQUIPMENT MAINTENANCE OUTSIDE THE EQUIPMENTS NORMAL MAINTENANCE SCOPE AND WHEN PERFORMING REQUIRED MAINTENANCE ON ANY POWER CABLE(S) CONNECTED TO THE EQUIPMENT.

## WARRANTY

Lake Shore Electric Automatic Transfer Switches are guaranteed against defective materials and workmanship for a period of one year from date of shipment. If, within one year after shipment, it is proved to Lake Shore's satisfaction that the equipment requires valid warranty and Lake Shore is promptly notified of same, Lake Shore will make necessary corrections, free of charge. F.O.B. works where manufactured.

Such necessary corrections constitute the full extent of Lake Shore's warranty. There are no warranties, which extend beyond those described herein. This warranty is exclusive and is in lieu of all other warranties, whether written, oral, implied or statutory. No warranty of merchantability or of fitness for purpose shall apply.

Lake Shore is not responsible for damage to its equipment through improper installation or use, unauthorized repair or modifications, or attempts to operate it above its rated capacities or in abnormal environments. In no event, whether as a failure to meet conditions of the warranty or otherwise, shall Lake Shore be liable for any special, incidental, or consequential damages, including, but not limited to, loss of profit or revenues, loss of good will, damages to associated equipment, cost of capital, cost of substitute products, facilities, service or replacement power, costs of downtime or claims of third parties for such damages.

**Notice:** The owner of this quick connection cabinet must perform periodic maintenance as described in this manual in order to maintain Lake Shore Electric Corporation's one year exclusive warranty. Failure to perform this maintenance shall void this warranty.

### NOTE

Engineering changes may have been made after publication date. Any departure from this manual should be checked with Lake Shore Electric Corporation.

Lake Shore Electric Corporation reserves the right to change specifications without prior notice.

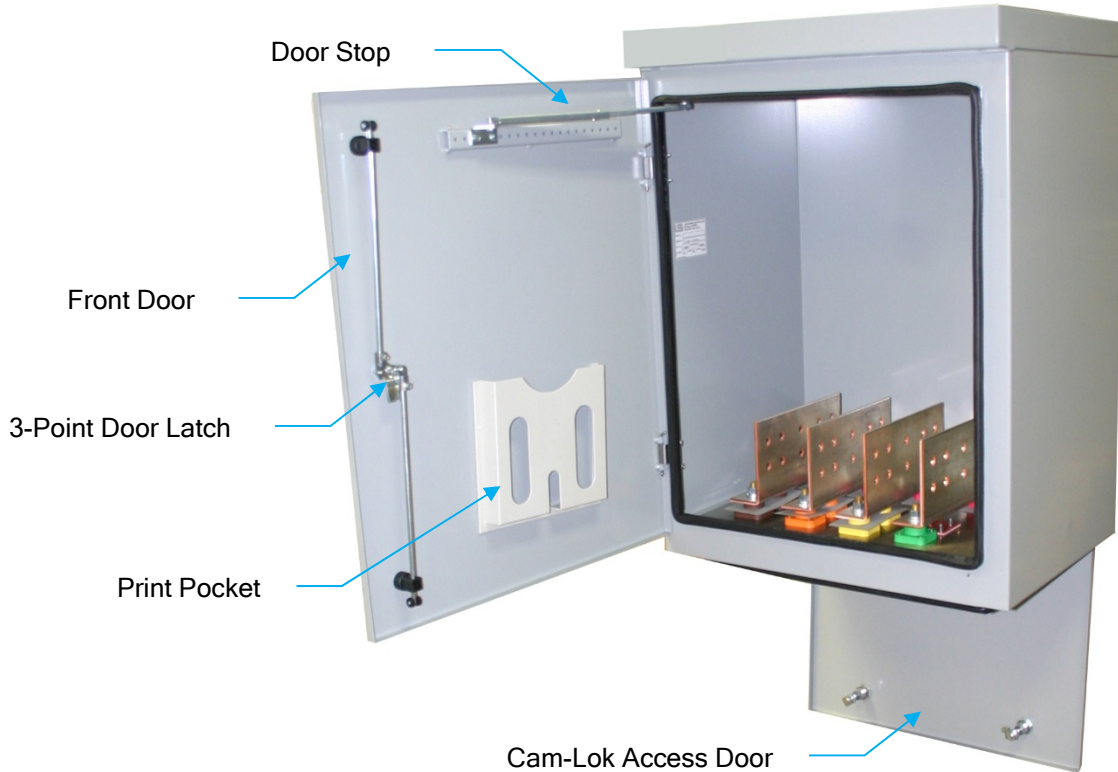

### OVERVIEW

Lake Shore Electric's Quick Connection Cabinets (QCC) are intended to provide a temporary connection to an emergency generator and a permanent connection to a building load.

### QCC INSTALLATION

**IMPORTANT!** When cables must be connected or disconnected to the QCC, the generator must be "OFF"!

Once determining the appropriate size cable to connect the QCC to the building load, conduits must enter from either the top or rear of the cabinet. If from the rear, they must be as close to the top as possible to allow for adequate cable bend area. Additionally, consideration must be given when rear connected to insure the conduit hub does not interfere with the mounting of the cabinet.

**NEVER** enter conduits from the bottom or the sides of the cabinet. In order to maintain the Nema 3R and Nema 4 ratings, insure that appropriate gaskets and/or seals are utilized during installation. The cabinet must be mounted level to allow for proper drainage through the integral weep holes located in the bottom of the unit.

**THE STANDARD QCC PRODUCT DOES NOT PROVIDE OVERCURRENT PROTECTION OF ANY KIND. IT MUST BE PROTECTED BY AN UP-STREAM CIRCUIT BREAKER TO MAINTAIN REQUIRED SHORT CIRCUIT RATINGS.**

Confirm that the generators voltage and phase sequence match that as provided with the QCC unit. The Cam-Loks are color coded with voltages and phase sequences clearly marked on a label inside the lower access door as well as included on the Outline drawing provided in the print pocket located inside the front door.

Minimal periodic maintenance is required other than visual inspection to insure proper operation. Inspect sealing of the doors and gaskets and check that the proper torque is maintained on the compression lugs (supplied by installer) at the load connection to the bus bars.

The required torque values are visible on a label located on the inside of the front door as well as on the Outline drawing located in the print pocket.

### E1016 SERIES CAM-LOK ASSEMBLY INSTRUCTIONS

If mating Cam-Lok connectors were order with the QCC, follow instructions below:

1. Measure the outer diameter of the cable jacket. Cable must be 4/0, rated 105°C. See Figure 1.

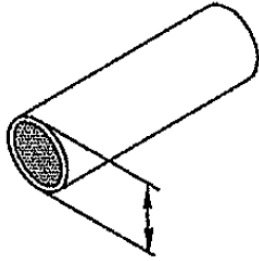

Figure 1

2. Cut the sleeve of the E1016 Cam-Lok so that the inner diameter matches the OD of the cable jack. See Figure 2.

NOTE: This connection must be as tight as possible so make sure to cut the correct size.

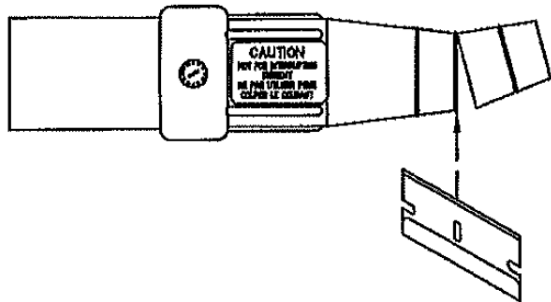

Figure 2

3. Apply lubricant to the cable jacket for an easier install of the cable into the E1016 Cam-Lok. See Figure 3.

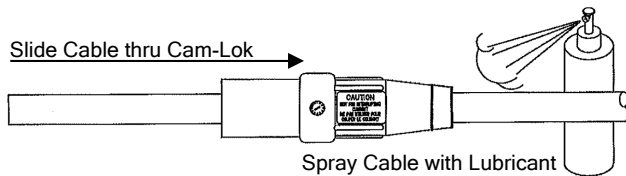

Figure 3

4. Remove the jacket from cable exiting the left side of the Cam-Lok. See Figure 4.

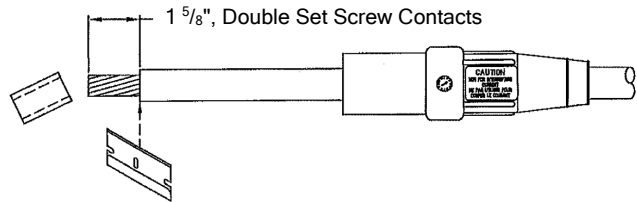

Figure 4

5. Wrap the exposed cable strands with copper shim. See Figure 5.

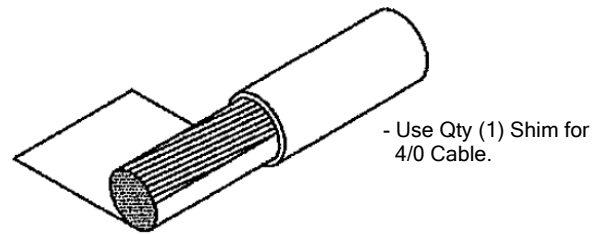

Figure 5

6. Wrap a strain relief wire around the cable jacket. See Figure 6.

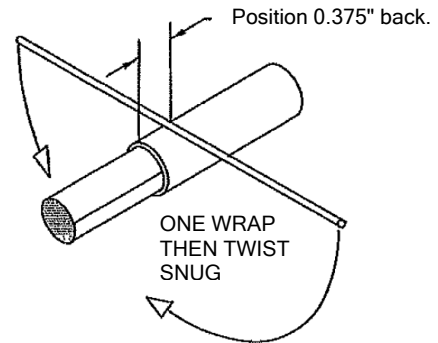

Figure 6

7. Trim the strain relief wire flush with the cable strands. See Figure 7.

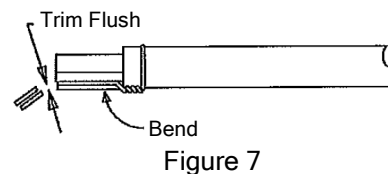

Figure 7

8. Insert the exposed cable strands with the strain relief into the contact. See Figure 8.

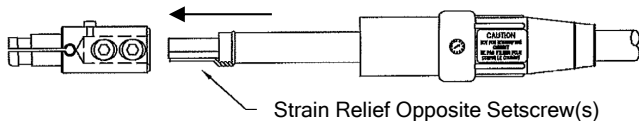

Figure 8

9. Tighten the setscrew(s) with a  $\frac{7}{32}$ " Allen Wrench; Clock wise rotation. Setscrew(s) must be flush with the contact.  
4/0 Cable: Torque to 220 inch pounds.  
See Figure 9.

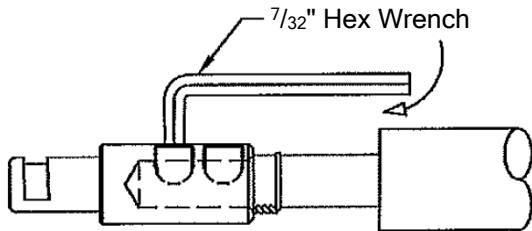

Figure 9

10. Liberally spray lubricant on the contact for insertion into the Cam-Lok sleeve. See Figure 10.

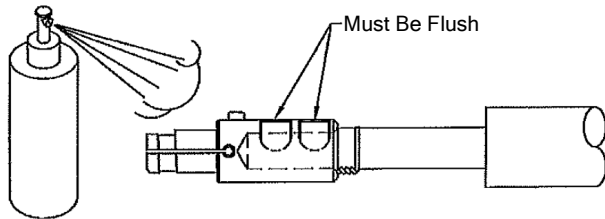

Figure 10

11. Line up the pin on the contact with the arrow on the Cam-Lok sleeve. See Figure 11.

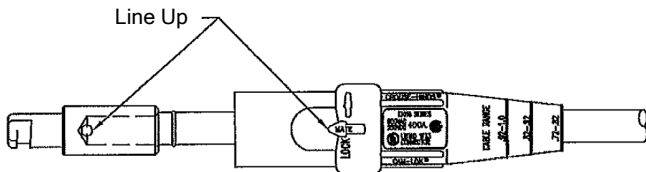

Figure 11

12. Push the Cam-Lok sleeve over the contact. See Figure 12.

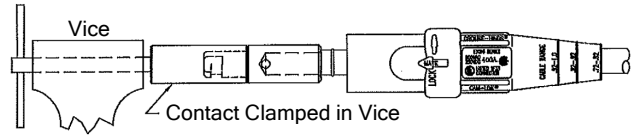

Figure 12

13. Pin must POP into pocket. See Figure 13.

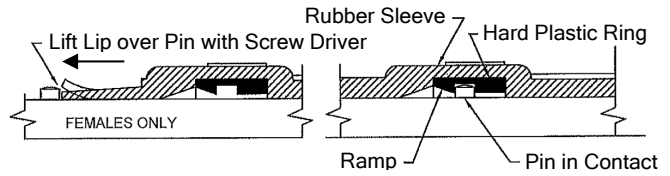

Figure 13

14. Check the final position of the contact within the Cam-Lok sleeve. See Figure 14.

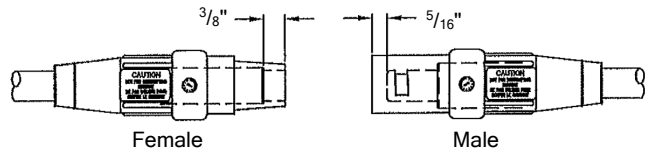

Figure 14

15. Assembly of first Cam-Lok complete. Repeat this process for all cables that must be made.

### E1016 SERIES SLEEVE REMOVAL INSTRUCTIONS

If there is a problem with the final connection and it needs to be redone, follow instructions below to remove the contact from the Cam-Lok sleeve.

1. Place contact into vice and tighten down. See Figure 15.

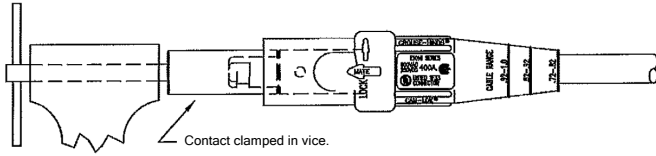

Figure 15

2. Insert 1/4" wide screw-driver into keyway. See Figure 16.

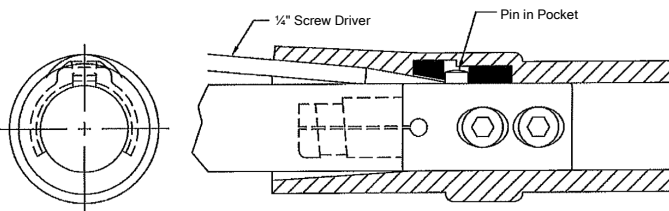

Figure 16

3. Rotate screw-driver blade 90° to lift the pin lock off the contact pin, then pull the Cam-Lok sleeve off. See Figure 17.

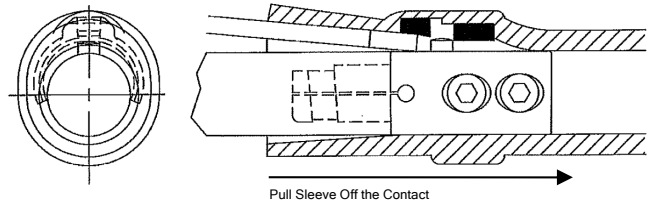



Figure 17

4. Removal of the Cam-Lok contact from its sleeve is complete. Remake the cable as needed.

### STANDARD CAM-LOK COLOR CODE BY VOLTAGE

Voltage	L1 (φA)	L2 (φB)	L3 (φC)	NEU	GND
120/240Vac	Black	Red	Blue	White	Green
277/480Vac	Brown	Orange	Yellow	White	Green



**LAKESHORE**  
ELECTRIC CORPORATION  
205 WILLIS STREET  
BEDFORD, OHIO 44114

QUICK CONNECTION CABINET  
CONFORMS TO UL STANDARD 1008



Model # **QCC0000XXX0000**

Serial # **###-####-###**

**120/208** VAC **60** Hz **0** Amps

**3** Phase **4** Wire Mfg Date Code **MMYYYY**

WHEN PROTECTED BY A CIRCUIT BREAKER OF THE SPECIFIC MANUFACTURER, TYPE, AND AMPERE RATING AS MARKED BELOW, THIS DEVICE IS SUITABLE FOR USE IN CIRCUITS CAPABLE OF DELIVERING THE SHORT-CIRCUIT CURRENT AT THE MAXIMUM VOLTAGE MARKED

SHORT-CIRCUIT CURRENT (RMS) SYMMETRICAL (AMPERE X 1000)	VOLTAGE (AC MAX)	MANUFACTURER	TYPE	RATING (AMPERES)
100	480	EATON-CIH	KDC	400
100	480	SQUARE-D	LL	400
100	480	EATON-CIH	NGU	800
100	480	SQUARE-D	RL	800
100	480	EATON-CIH	NGU	1200
100	480	SQUARE-D	RL	1200

**DANGER—RISK OF ELECTRIC SHOCK**  
FOR USE ONLY FOR CONNECTION OF A PORTABLE GENERATOR TO THE TERMINALS OF A TRANSFER SWITCH SUCH THAT THE INLETS ARE ONLY ENERGIZED FROM THE GENERATOR.  
DO NOT START GENERATOR UNTIL ALL CABLES ARE CONNECTED. ANY TERMINAL MAY BE ENERGIZED WHEN ANY CABLE IS CONNECTED. DE-ENERGIZE CABLES AT GENERATOR PRIOR TO CONNECTING OR REMOVING ANY CONNECTORS.

**ENVIRONMENTAL RATING**  
NEMA 4 WHEN ALL DOORS LATCHED CLOSED.  
NEMA 3R WHEN FRONT DOOR LATCHED CLOSED AND BOTTOM DOOR OPEN ONLY AFTER ALL MATING CAM-LOKS ARE INSTALLED.

58LSEPR7679B30

### CAUTION: READ INSTRUCTIONS BEFORE USE

PREFERRED MATING CAM-LOK CONNECTOR: **CROUSE-HINDS E1016 "J" SERIES**

NOTE: **INLET CONNECTIONS TO BE MADE BY QUALIFIED PERSONNEL ONLY**

NOTICE: **DISCONNECTS NOT TO BE USED FOR INTERRUPTING CURRENT**

CAM-LOK™ CONNECTOR RATING: 400A MAX @600VAC 60Hz WITH CABLE RATED 105° C MINIMUM  
360A MAX @600VAC 60Hz WITH CABLE RATED <105° C

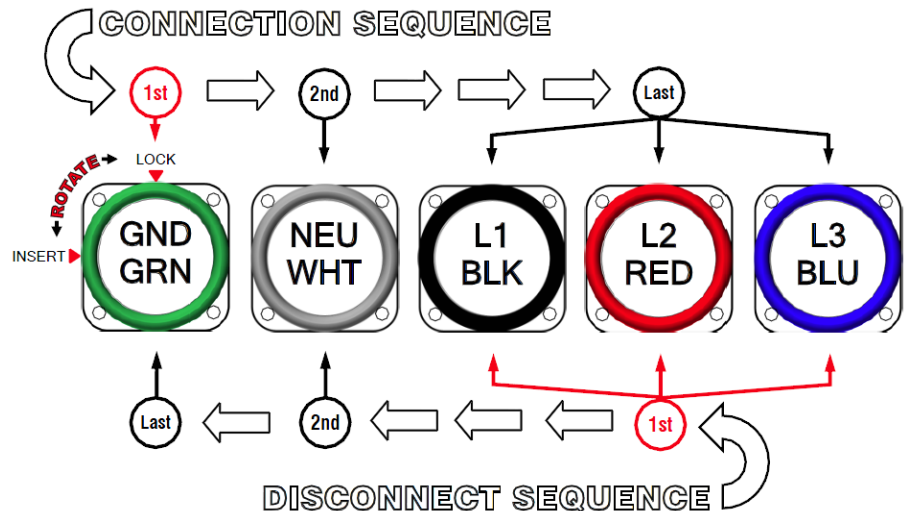

Contact Information  
p:800.225.0141  
f:440.232.5644  
[sales@lake-shore-electric.com](mailto:sales@lake-shore-electric.com)  
[www.lake-shore-electric.com](http://www.lake-shore-electric.com)

Location of Factory  
Lake Shore Electric  
205 Willis Street  
Bedford, OH 44146