

UTILITY TRANSFORMER METERING CABINET

48x48x12 ENCLOSURE, 600VAC, TYPE 3R

APPLICATION

Lake Shore Electric's American Electric Power approved utility transformer metering enclosure offers Type 3R protection and includes a 3/4" treated plywood back plate for mounting utility-supplied current transformers.



Industry Standard:

UL 414 Listed; Type 3R
File No. E240038

FEATURES

- Overlapping double-door with 3-point latch
- 316-Stainless steel lift-off hinges
- Stainless steel handle with padlock provisions
- Door stop
- 3/4" Treated Plywood Backplate
- Drip-shield top and seam-free sides and back
- Ground lug provided, #6-250MCM AWG, single conductor

PRODUCT SPECIFICATION

Utility Co.	Installation	Electrical Specifications	Dimensions (H x W x D)	Lb	Lug Size
American Electric Power	Wall Mount	N/A	48 x 48 x 12	270	N/A

UTMC MODEL CODES

Model	Finish	Enclosure Material
UTMC-HD-484812-USN-3B-AEP-00*	Mill Finish	Aluminum
UTMC-HD-484812-USN-3C-AEP-00*	#4 Brushed Finish	304 Stainless Steel
UTMC-HD-484812-USN-3D-AEP-00*	#4 Brushed Finish	316 Stainless Steel
UTMC-HD-484812-USN-3E-AEP-00	Gray Polyester Powder Coat	A60 Galvanneal

* Enclosure ventilator included per AEP Corrosive Environments requirements

LEG KITS

Model	Finish	Leg Kit Material
UTMC-LK-484812-3C	#4 Brushed Finish	304 Stainless Steel
UTMC-LK-484812-3D	#4 Brushed Finish	316 Stainless Steel
UTMC-LK-484812-3E	Gray Polyester Powder Coat	A60 Galvanneal

lseenclosure.com/utmc

UTILITY TRANSFORMER METERING CABINET
48x48x12 ENCLOSURE, 600VAC, TYPE 3R

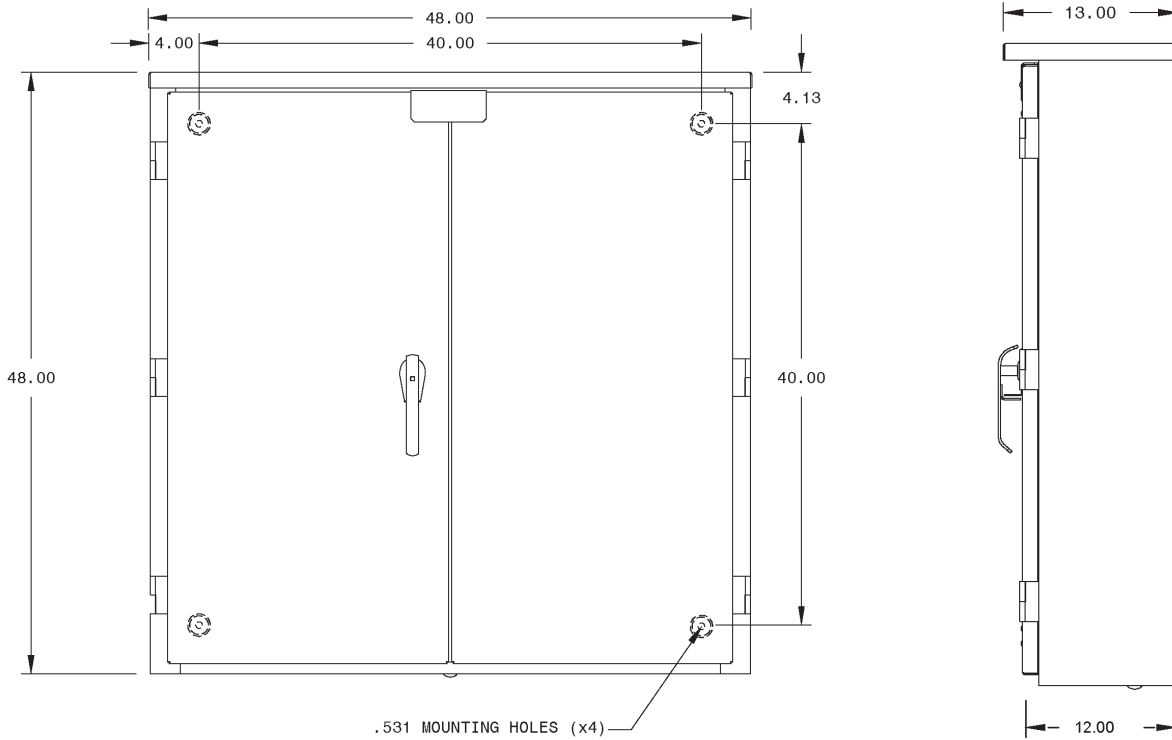
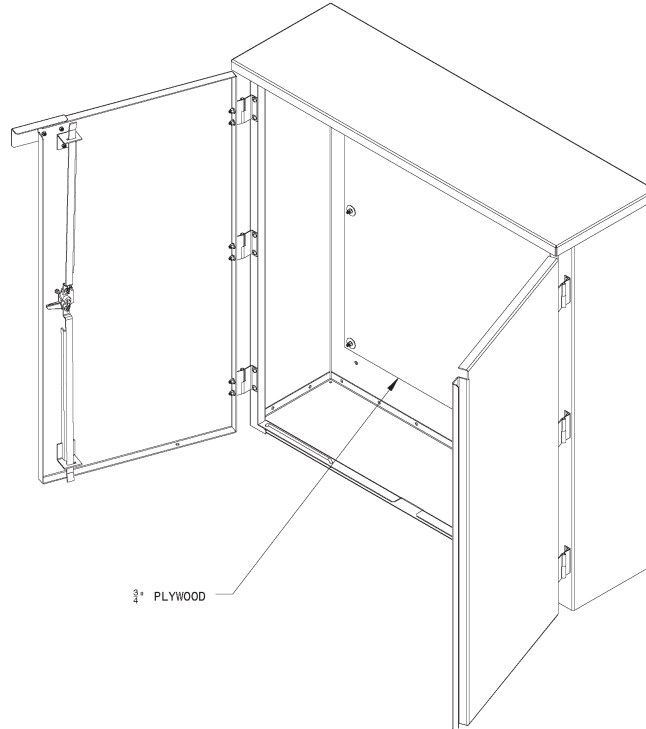

lseenclosure.com/utmc