

Automatic Transfer Switch

AMD Molded Case Dual Motor

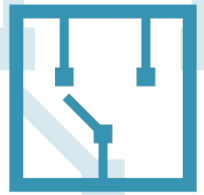

Model: 600A-1200A

Technical Data	
Standard & Optional Features	2
150A & 225A Frame	4
400A & 600A Frame	5
800A & 1200A Frame.....	6
Controller Features & Accessories	7
Adjustable Features & Factory Defaults	8
Selection Guide	
Characters & Designations	9
Model Code Configuration	10
Accessory Code Configuration	11
Overcurrent Trip Rating	13
Weights & Dimensions	
AMD Transfer Switch (150A - 400A)	14
AMD Transfer Switch (600A - 1200A)	15
Connection Information	
Mechanical Lug Size & Quantity	16

TRANSFER

Lake Shore Electric's AMD Automatic Transfer Switch utilizes industry-proven molded case switches to perform safe transfers under load. The AMD Transfer Switch is UL 1008 listed and offered in ampacities ranging from 150A to 1200A, up to 600VAC, and interrupting ratings starting at 35kAIC @480VAC. Service entrance rated, as well as open and closed transition configurations are also available.

Standard Features:

- 8600 Transfer Switch Controller
- Molded Case Switches
- 100% Rated Copper Bus
- Front Accessible
- Mechanically Interlocked Sources (Open Transition)
- Neutral Position
- Automatic & Manual Operation Under Load
- Engine Starting Contacts
- Momentary Load Test
- NEMA 1 Enclosure with Gray Powder Coat Finish

Optional Features:

- Service Entrance Rated
- Breaker Trip Ratings
- Closed Transition Transfer
- Space Heater
- Surge Protection Device
- Mechanical Lug Sizes
- 861 Ethernet Communication Gateway
- Metering/Power Monitoring
- Remote Disconnect
- Utility to Utility or Generator to Generator Configurations

Technical Data

Standard & Optional Features

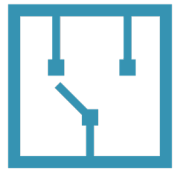

8600 Transfer Switch Controller

The 8600 Transfer Switch Controller monitors the voltage and frequency of the power on the Normal Source (Source 1) and Alternate Source (Source 2). The factory programmed monitoring set points can be adjusted on the display screen or with the Controller software on a PC to meet specific application requirements. The Controller can also be PIN protected to ensure no unauthorized changes can be made. See page 7 for more information.

Molded Case Units

The AMD utilizes two UL 489-listed molded case switches and/or breakers. Switches are constructed using circuit breaker components and are of the high instantaneous automatic type, tripping at 10X the frame rating. Breakers can be configured with either thermal magnetic or electronic trip units.

Mechanically Interlocked Sources

A walking beam-style mechanical interlock is used to prevent the unintentional paralleling of the Normal Source (Source 1) and Alternate Source (Source 2). Strategically located on the rear side of the back pan, the restricted access to the walking beam ensures a touch-free and tamper-resistant interlock.

Neutral Position

The AMD Transfer Switch allows for both sources to be placed in the “off” or neutral position.

Automatic & Manual Operation

The AMD Transfer Switch is an electrically operated and mechanically held self-contained power switching assembly. The Transfer Switch can be operated automatically or manually by selecting the desired mode on the 8600 Controller. Motor operators and handles are located on the front of the Normal Source (Source 1) and Alternate Source (Source 2) molded case units for safe manual transfer under load.

Engine Starting Contacts

The 8600 Transfer Switch Controller provides one form “C” dry contact output that is initiated upon sensing the loss of the Normal Source.

NEMA 1 Enclosure with Gray Powder Coat Finish

All AMD Transfer Switch enclosures come standard with an environmental rating of NEMA Type 1, with a textured gray powder coat finish. See page 10 for additional NEMA ratings and materials that are available.

Source Configuration

The AMD Transfer Switch’s standard configuration was engineered to transfer between two distinct power sources, such as utility power and an Alternate generator. The option to transfer between two of the same types of power sources (e.g. utility to utility or generator to generator) can be specified by selecting the corresponding Source Configuration. Please note: The generator to generator scheme does not allow for both sources to be on standby at the same time, and requires that one source continually run and provide power to the ATS. See page 11 for more information.

Standard & Optional Lug Sizes

Mechanical lugs are provided for all incoming and outgoing connections. See table on page 16 for available lug sizes. Compression lugs are not available on the AMD Transfer Switch.

Technical Data

Standard & Optional Features (cont.)

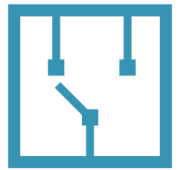

Service Entrance Rated (Optional)

The service entrance rated option provides overcurrent protection on the Normal Source (Source 1), allowing it to be designated as a means of service disconnect. A neutral ground bond is also provided (where applicable). Service entrance rated AMD's that are 1000A and greater come standard with arc flash reduction features and ground fault protection when service disconnects installed on solidly grounded wye electrical systems over 150 volts to ground.

Breaker Trip Ratings (Optional)

The AMD can be configured to include overcurrent protection on both the Normal Source (Source 1) and the Alternate Source (Source 2). The available trip sizes are based on the frame amperage of the breaker. See page 13 for a full list of available trip sizes.

Closed Transition Transfer (Optional)

The Closed Transition Transfer option allows the ATS to seamlessly switch between power sources, ensuring an uninterrupted supply to the load. This is achieved by synchronizing both sources and allowing the Alternate Source (Source 2) to close before opening the Normal Source (Source 1), thus performing a "make before break" transfer. Both sources will be closed in parallel for a maximum of 100 milliseconds. An electrical interlock is provided in place of the standard mechanical interlock.

Please note: Closed transition or "make before break" transfer can only occur if both power sources are available and synchronized. If one is unavailable or not synchronized, the Transfer Switch will revert to open transition or "break before make", which may result in a momentary power interruption during the transfer.

Space Heater (Optional)

A 50W heater is provided on a constant circuit to aid in the regulation of the interior temperature and mitigate the formation of condensation in the enclosure and on the internal components.

Surge Protection Device (Optional)

A surge protection device (SPD) is included on the Normal Source to protect the control circuitry from transient voltage surges.

Table 1 : SPD Size

Amperage	SCCR	Line to Neutral
150A - 400A	200kA	20kA
600A - 1200A	200kA	20kA

861 USB to Ethernet Communication Device (Optional)

The 861 USB to Ethernet Communication Device is an optional accessory that allows for the monitoring of an 8600 Controller with USB connectivity over a LAN (network) or WAN (internet) connection. The device includes an LED indicator that shows the operation and connection status of the ATS and allows up to four users to simultaneously monitor the controller's status remotely. See page 7 for more information.

Metering/Power Monitoring (Optional)

Metering/Power Monitoring is an optional accessory available on the 8600 Automatic Transfer Switch Controller, which monitors kWh, kVAr, kVAh, and kVArh. This accessory also allows for customer-configurable load shedding. See page 7 for more information.

Remote Disconnect (Optional)

A shunt trip input is provided so that either or both of the switches can be tripped and the transfer switch sent in to the Fault mode. A manual reset of the switch is required. Customer interconnection can be made at a terminal block.

Technical Data

150A & 225A Frame

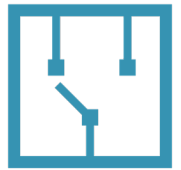

Table 2 : 150 Amp Frame Molded Case Details

kAIC @ 480V	Rated Current (A)	Breaker Model Code			Switch Model Code		
		2 Pole	3 Pole	4 Pole	2 Pole	3 Pole	4 Pole
35	50	FD2050	FD3050	FD4050			
	70	FD2070	FD3070	FD4070			
	100	FD2100	FD3100	FD4100			
	110	FD2110	FD3110	FD4110			
	125	FD2125	FD3125	FD4125			
	150	FD2150	FD3150	FD4150	FD2150K	FD3150K	FD4150K
65	50	HFD2050	HFD3050	HFD4050			
	70	HFD2070	HFD3070	HFD4070			
	100	HFD2100	HFD3100	HFD4100			
	110	HFD2110	HFD3110	HFD4110			
	125	HFD2125	HFD3125	HFD4125			
	150	HFD2150	HFD3150	HFD4150	HFD2150K	HFD3150K	HFD4150K

Table 3 : 225 Amp Frame Molded Case Details

kAIC @ 480V	Rated Current (A)	Breaker Model Code			Switch Model Code		
		2 Pole	3 Pole	4 Pole	2 Pole	3 Pole	4 Pole
35	100	KD2100	KD3100	KD4100			
	125	KD2125	KD3125	KD4125			
	150	KD2150	KD3150	KD4150			
	175	KD2175	KD3175	KD4175			
	200	KD2200	KD3200	KD4200			
	225	KD2250	KD3250	KD4250	KD2400K	KD3400K	KD4400K
65	100	HKD2100	HKD3100	HKD4100			
	125	HKD2125	HKD3125	HKD4125			
	150	HKD2150	HKD3150	HKD4150			
	175	HKD2175	HKD3175	HKD4175			
	200	HKD2200	HKD3200	HKD4200			
	225	HKD2250	HKD3250	HKD4250	HKD2400K	HKD3400K	HKD4400K

- Models stated above are Eaton C Series Molded Case Switches
- 3-pole variant with the center phase open may be used in place of a 2-pole at LSE discretion
- A higher withstand rating and/or frame rating may be used in place of a lesser rating at LSE discretion
- Contact factory for technical information on switching devices or withstand ratings not listed in Table
- Data subject to change without notice

Technical Data

400A & 600A Frame

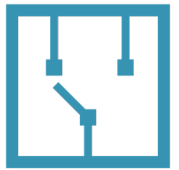

Table 4 : 400 Amp Frame Molded Case Details

kAIC @ 480V	Rated Current (A)	Breaker Model Code			Switch Model Code		
		2 Pole	3 Pole	4 Pole	2 Pole	3 Pole	4 Pole
35	200	KD2200	KD3200	KD4200			
	250	KD2250	KD3250	KD4250			
	300	KD2300	KD3300	KD4300			
	350	KD2350	KD3350	KD4350			
	400	KD2400	KD3400	KD4400	KD2400K	KD3400K	KD4400K
65	200	HKD2200	HKD3200	HKD4200			
	250	HKD2250	HKD3250	HKD4250			
	300	HKD2300	HKD3300	HKD4300			
	350	HKD2350	HKD3350	HKD4350			
	400	HKD2400	HKD3400	HKD4400	HKD2400K	HKD3400K	HKD4400K

Table 5 : 600 Amp Frame Molded Case Details

kAIC @ 480V	Rated Current (A)	Breaker Model Code			Switch Model Code		
		2 Pole	3 Pole	4 Pole	2 Pole	3 Pole	4 Pole
35	300	LD2300	LD3300	LD4300			
	350	LD2350	LD3350	LD4350			
	400	LD2400	LD3400	LD4400			
	450	LD2450	LD3450	LD4450			
	500	LD2500	LD3500	LD4500			
	600	LD2600	LD3600	LD4600	LD2600WK	LD3600WK	LD3600WK
65	300	HLD2300	HLD3300	HLD4300			
	350	HLD2350	HLD3350	HLD4350			
	400	HLD2400	HLD3400	HLD4400			
	450	HLD2450	HLD3450	HLD4450			
	500	HLD2500	HLD3500	HLD4500			
	600	HLD2600	HLD3600	HLD4600	HLD2600WK	HLD3600WK	HLD3600WK

- Models stated above are Eaton C Series Molded Case Switches
- 3-pole variant with the center phase open may be used in place of a 2-pole at LSE discretion
- A higher withstand rating and/or frame rating may be used in place of a lesser rating at LSE discretion
- Contact factory for technical information on switching devices or withstand ratings not listed in Table
- Data subject to change without notice

TRANSFER

Technical Data

800A & 1200A Frame

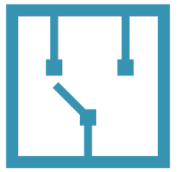

Table 6 : 800 Amp Frame Molded Case Details

kAIC @ 480V	Rated Current (A)	Breaker Model Code			Switch Model Code		
		2 Pole	3 Pole	4 Pole	2 Pole	3 Pole	4 Pole
50	800 LSI	NGS208032E	NGS308032E	NGS408032E		NGK3080KSE	NGK4080KSE
65	800 LSI	NGH208032E	NGH308032E	NGH408032E		NGK3080KSE	NGK4080KSE

Table 7 : 1200 Amp Frame Molded Case Details

kAIC @ 480V	Rated Current (A)	Breaker Model Code			Switch Model Code		
		2 Pole	3 Pole	4 Pole	2 Pole	3 Pole	4 Pole
50	1200 LSI	NGS212032E	NGS312032E	NGS412032E			
	1200 LSI SIG	NGS212036E	NGS312036E	NGS412036E		NGK3120KSE	NGK4120KSE
65	1200 LSI	NGH212032E	NGH312032E	NGH412032E			
	1200 LSI SIG	NGH212036E	NGH312036E	NGH412036E		NGK3120KSE	NGK4120KSE

- Models stated above are Eaton C Series Molded Case Switches
- 3-pole variant with the center phase open may be used in place of a 2-pole at LSE discretion
- A higher withstand rating and/or frame rating may be used in place of a lesser rating at LSE discretion
- Contact factory for technical information on switching devices or withstand ratings not listed in Table
- Data subject to change without notice

Technical Data

Controller Features & Accessories

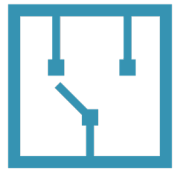

Controller Description & Overview

The 8600 Automatic Transfer Switch Controller monitors the voltage and frequency of the AC supply from two potential sources, such as a generator, utility, or a combination of both. If the supply from Source 1 (S1) fails, the Controller will issue a start command to Source 2 (S2). The 8600 Automatic Transfer Switch Controller will transfer the load to S2 once it produces an output that meets the required limits. When S1's supply returns and meets the specified limits, the load will then be switched back, and S2 will be shut down. To prevent unnecessary start commands, the 8600 offers various timing sequences.

- Standard Features:
- 4-Line Back-Lit LCD Text Display
- Five Key Menu Navigation
- Front Panel Editing with PIN Protection
- LED & LCD Alarm Indication
- Source 1/Source 2 Control
- Engine Test and Start Contact
- Load Inhibit
- Single Phase Protection
- Manual Restore to S1
- Configurable Timers & Alarms
- Event Log
- Multiple Date & Time Scheduler
- USB Connectivity
- Backed Up Real Time Clock
- Configurable Display Languages
- RS485 Communications
- Load Shedding Outputs (Requires Metering Accessory)



861 USB to Ethernet Communication Device (Optional)



The 861 USB to Ethernet Communication Device is an optional accessory that is used in conjunction with the 8600 Automatic Transfer Switch Controller to allow for remote monitoring of an ATS over a LAN (network) or WAN (internet) connection. The device includes an LED indicator that shows the operation and connection status of the ATS and allows up to four users to simultaneously monitor the Controller's status remotely.

- Converts Controller's USB port to an Ethernet port
- Built-in web server for use over an internal network and the internet
- Simple configuration via an internet browser
- Remote control and monitoring of the connected controller
- User access permission/restrictions available
- Supports MODBUS TCP via Ethernet port
- LED status indication on the device to aid fault finding

Metering/Power Monitoring (Optional)

Metering/Power Monitoring is an optional accessory for the 8600 Automatic Transfer Switch Controller, which can monitor kWh, kVAR, kVAh, and kVAh. This accessory also allows the user to configure the Controller for load-shedding applications that can be communicated via the native Modbus RS-485 or the optional Ethernet communication module shown above.

Technical Data

Adjustable Controller Features & Factory Defaults

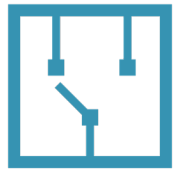
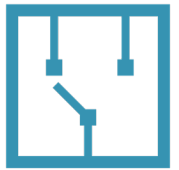

Table 8 : Controller Features			
Set Point	Description	Factory Default	Range
TDES	Time Delay Engine Start	3 Seconds	0 Seconds - 10 Hours
TDNE	Time Delay Normal to Alternate	3 Seconds	0 Seconds - 5 Hours
TDEN	Time Delay Alternate to Normal	3 Seconds	0 Seconds - 5 Hours
TDEC	Time Delay Engine Cool-Off	3 Seconds	0 Seconds - 1 Hours
TDN	Time Delay Neutral	3 Seconds	0 Seconds - 5 Hours
TDEF	Time Delay Alternate Fail Timer	3 Seconds	0 Seconds - 1 Hour
TPRE	Pre-Transfer Delay Timer	10 Seconds	0 Seconds - 5 Minutes
S1 UV DROP	S1 Undervoltage Dropout	80% of the Nominal Voltage	
S1 UV PICK	S1 Undervoltage Pickup	90% of the Nominal Voltage	
S2 UV DROP	S2 Undervoltage Dropout	80% of the Nominal Voltage	
S2 UV PICK	S2 Undervoltage Pickup	90% of the Nominal Voltage	
Check Sync	Synchronization	Off	0 Seconds - 10 Minutes
TD	Transient Delay	Off	0 Seconds - 30 Seconds
PHASES	Three-Phase or Single-Phase	Refer to Model Code or Schematic	
PLANT EXER	Plant Exerciser Programming	Off	Week/Day/Time/Duration
PHASE ROT	Phase Rotation	Off	(L1, L2, L3) OR (L3, L2, L1)

Table 9 : Contacts			
Available Contacts	Contact Type	Contact Position	Rating
Alarm	Dry	Form C	10A @250VAC
Pre-Transfer Contact	Dry	Form C	10A @250VAC
S1 Available	Dry	Form C	10A @250VAC
S2 Available	Dry	Form C	10A @250VAC
Engine Start	Dry	Form C	8A @ 250VAC
S1 Switch Position	Dry	Auxiliary	6A @ 250VAC
S2 Switch Position	Dry	Auxiliary	6A @ 250VAC
Remote Disconnect	Wet	Digital Input	N/A
Peak Shave	Wet	Digital Output	N/A

Selection Guide

Characters & Designations



All Lake Shore Electric Transfer products are designed by using a structured, smart-style model code ordering system. The complete AMD model code is composed of 26 customer-selected characters, with each identifying a feature or function of the design. The first thirteen characters of the model code define the basic configuration. The thirteen characters that follow identify the Controller type, service rating, and any additional accessories.

Sample Model Code:

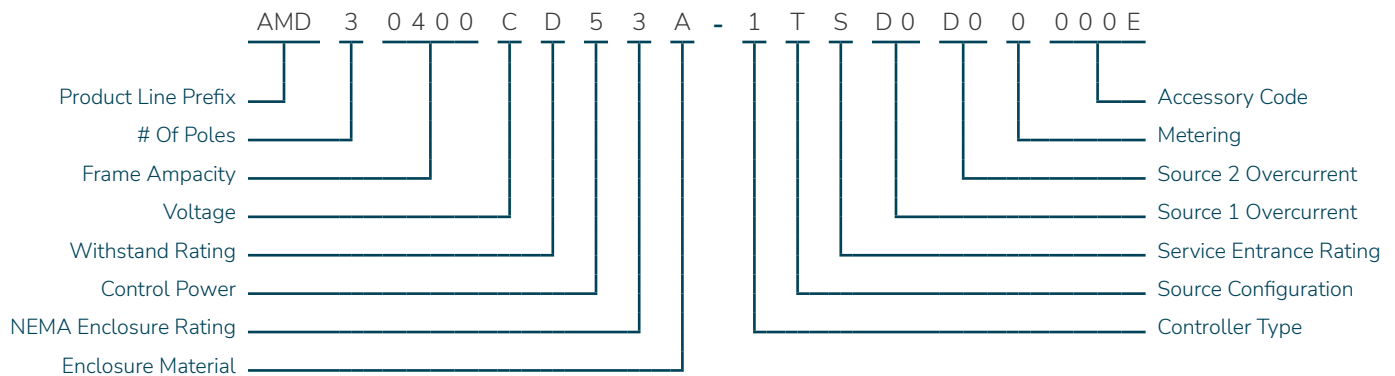

Selection Guide

Model Code Configuration

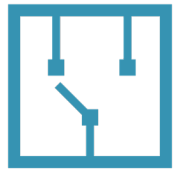

Number of Poles

Following the AMD prefix of the model code is the number of poles. Available in configurations of 2–pole, 3–pole, and 4–pole, this character is what distinguishes between a solid or switched neutral.

Table 10 : Number of Poles

Poles	Alpha Numeric
2	2
3	3
4	4

Frame Ampacity

The AMD product line is designed using industry standard molded case frame sizes and is available in amperages ranging from 150A - 1200A. A breaker trip rating can be selected for both the Normal and Alternate Source based on the frame size chosen below. See page 13 for a complete list of available trips,

Table 11 : Amperage Codes

Amp Frame	Alpha Numeric
150	0150
225	0225
400	0400
600	0600
800	0800
1200	1200

Voltage

Identification of the system voltage determines the number of phases as well as the presence of a neutral wire.

Table 12 : Voltage Codes

Voltage	Phase/Wire	Alpha Numeric
120/240VAC	1 Ph 3W	A
208Y/120VAC	3 Ph 4W	B
480Y/277VAC	3 Ph 4W	C
120/240VAC	3 Ph 4W	G
480VAC	3 Ph 3W	K

Withstand Rating

The withstand rating is based on UL 489 & 1066 Switching Device Ratings at 480VAC; Lower voltages offer higher kAIC ratings within the same alphanumeric code. Contact the factory for these ratings.

Table 13 : Withstand Rating Codes

kAIC	Alpha Numeric
35kAIC @ 480V	D
50kAIC @ 480V	F
65kAIC @ 480V	G
100kAIC @ 480V	I

Control Power Supply

Control power is externally derived from the engine generator battery system. If external power is not available, internally derived power can be provided via DC Uninterrupted Power Supply (UPS) which provides a minimum 15 minutes of backup power.

Table 14 : DC Power Supply

Control Power	Alpha Numeric
Externally Derived (12VDC - 24VDC)	5
Internally Derived (UPS)	8

NEMA Enclosure Rating

AMD Transfer Switches are available in NEMA Type 1 or NEMA Type 3R enclosures.

Table 15 : NEMA Code

Enclosure Rating	Alpha Numeric
NEMA 1	1
NEMA 3R	3

Enclosure Material

The standard enclosure material of the AMD Transfer Switch is hot rolled steel with a textured ANSI-61 gray powder coat finish. Additional material options are listed below.

Table 16 : Enclosure Code

Material	Alpha Numeric
Hot Rolled Steel (Powder Coat Finish)	A
Stainless Steel – 304 (#4 Brushed Finish)	C
Stainless Steel – 316 (#4 Brushed Finish)	D

Selection Guide

Accessory Code Configuration

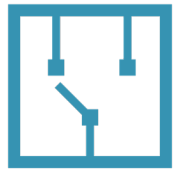

Controller Type

The first character after the hyphen specifies the Transfer Switch Controller, with the Standard Controller Package (Alpha Numeric 1) being the default selection for all Automatic Transfer Switches. See page 7 for Controller and Ethernet Communication Module details.

Table 17 : Controller

Description	Alpha Numeric
Standard Controller Package	1
Standard Controller Package with Ethernet	2

Source Configuration

The second character after the hyphen identifies the power source type. The AMD Transfer Switch's standard configuration switches between two distinct power source types, such as a Normal Source and an Alternate generator (Alpha Numeric T). Alternative configurations are listed below.

Table 18 : Source

Configuration	Alpha Numeric
S1 Utility & S2 Generator	T
S1 Utility & S2 Utility	P
S1 Generator & S2 Generator	G

Service Entrance Rating Code

Following the source configuration character is the option for service entrance rated or non-service entrance rated. See page 3 for more information.

Table 19 : SER Code

Rating	Alpha Numeric
Non-Service Entrance Rated	N
Service Entrance Rated	S

Source 1 Overcurrent

The AMD can be configured to include overcurrent protection on the Normal Source (Source 1) which is based on the frame ampacity as selected on page 10. The table below lists the default two-character trip rating offered on the Normal Source (S1) as well as the option for no overcurrent protection. Additional trip rating codes and selection instructions are available on page 13.

Table 20 : S1 Default Trip Rating

Rating	Alpha Numeric
No Source 1 Trip (Switch Only)	00
150A Thermal Magnetic	A0
225A Thermal Magnetic	C0
400A Thermal Magnetic	D0
600A Thermal Magnetic	E0
800A LSI	F0
1200A LSI	G0

Source 2 Overcurrent

The option to include overcurrent protection on the Alternate Source (Source 2) is also available and is based on the frame ampacity as selected on page 10. The table below lists the default two-character trip rating offered on the Alternate Source (S2), as well as the option for no overcurrent protection. Additional trip rating codes and selection instructions are available on page 13.

Table 21 : S2 Default Trip Rating

Rating	Alpha Numeric
No Source 2 Trip (Switch Only)	00
150A Thermal Magnetic	A0
225A Thermal Magnetic	C0
400A Thermal Magnetic	D0
600A Thermal Magnetic	E0
800A LSI	F0
1200A LSI	G0

Selection Guide

Accessory Code Configuration (cont.)

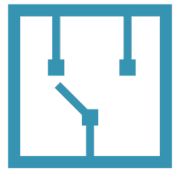

Metering/Power Monitoring

Selection of this accessory is to include Metering/Power Monitoring on the Load. Because this is an optional accessory, the default selection for all Automatic Transfer Switches is Alpha Numeric 0.

Table 22 : Metering

Rating	Alpha Numeric
No Meter/Power Monitoring	0
Meter/Power Monitoring on Load	3

Accessory Code Position 1

The first position of the four-digit accessory code allows for the addition of a remote disconnect, as well as closed transition transfer.

- Remote Disconnect provides a shunt trip input so that either or both of the switches can be opened from a remote location and the Transfer Switch sent to the Fault mode.
- Closed Transition Transfer allows the ATS to transfer between sources without interruption of power to the load. See page 3 for more information

Table 23 : Accessory Code 1

Description	Alpha Numeric
No Option	0
Remote Disconnect	1
Closed Transition Transfer	2
Remote Disconnect & Closed Transition	3

Accessory Code Position 2

The second position of the four-digit accessory code provides the option to include a space heater.

- Space Heaters operate on 120VAC and may include a control power transformer when necessary. OverCurrent protection is also provided.

Table 24 : Accessory Code 2

Description	Alpha Numeric
No Option	0
Space Heater	1

Accessory Code Position 3

The third position of the four-digit accessory code is used to specify the need for an Alternate lug size and/or Surge Protection Device (SPD).

- Optional Lug sizes can be found on page 16
- Surge Protection Device's are sized per the frame amperage of the ATS. See page 3 for more information.

Table 25 : Accessory Code 3

Description	Alpha Numeric
No Option (Standard Lug Size)	0
Optional Lug Size	1
Surge Protection Device	2
Optional Lug Size & Surge Protection Device	3

Accessory Code Position 4

The fourth position of the four-digit accessory code is a fixed character with no selection required.

Table 26 : Accessory Code 4

Description	Alpha Numeric
Manufacturer Code	E

Selection Guide

Overcurrent Trip Rating

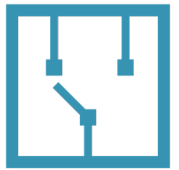

The tables below provide a list of available trip ratings based on the AMD frame ampacity as selected on page 10. Different trip ratings within the same breaker frame size can be selected for each source (example below). The default two-character trip rating of each frame size has been highlighted. Refer to table 20 & 21 on page 11 if overcurrent protection is not needed.

Fixed Thermal Magnetic Trip

Table 27 : 150A Frame

Trip	Alpha Numeric
150A	A0
125A	A5
110A	A4
100A	A3
70A	A2
50A	A1

Table 28 : 400A Frame

Trip	Alpha Numeric
400A	D0
350A	D4
300A	D3
250A	D2
200A	D1

Table 29 : 225A Frame

Trip	Alpha Numeric
225A	C0
200A	C5
175A	C4
150A	C3
125A	C2
100A	C1

Table 30 : 600A Frame

Trip	Alpha Numeric
600A	E0
500A	E5
450A	E4
400A	E3
350A	E2
300A	E1

Adjustable Electronic Trip

Table 31 : 800A Frame

Trip	Alpha Numeric
800A	F0

Table 32 : 1200A Frame

Trip	Alpha Numeric
1200A LSIG	G0
1200A LSI	G1

Trip Rating Selection Example

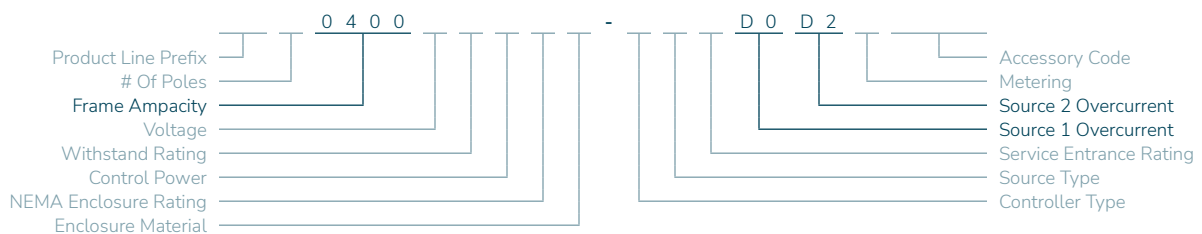

Weights & Dimensions

AMD Transfer Switch (150A - 400A)

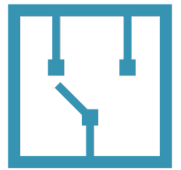

Exterior Layout & Dimensions

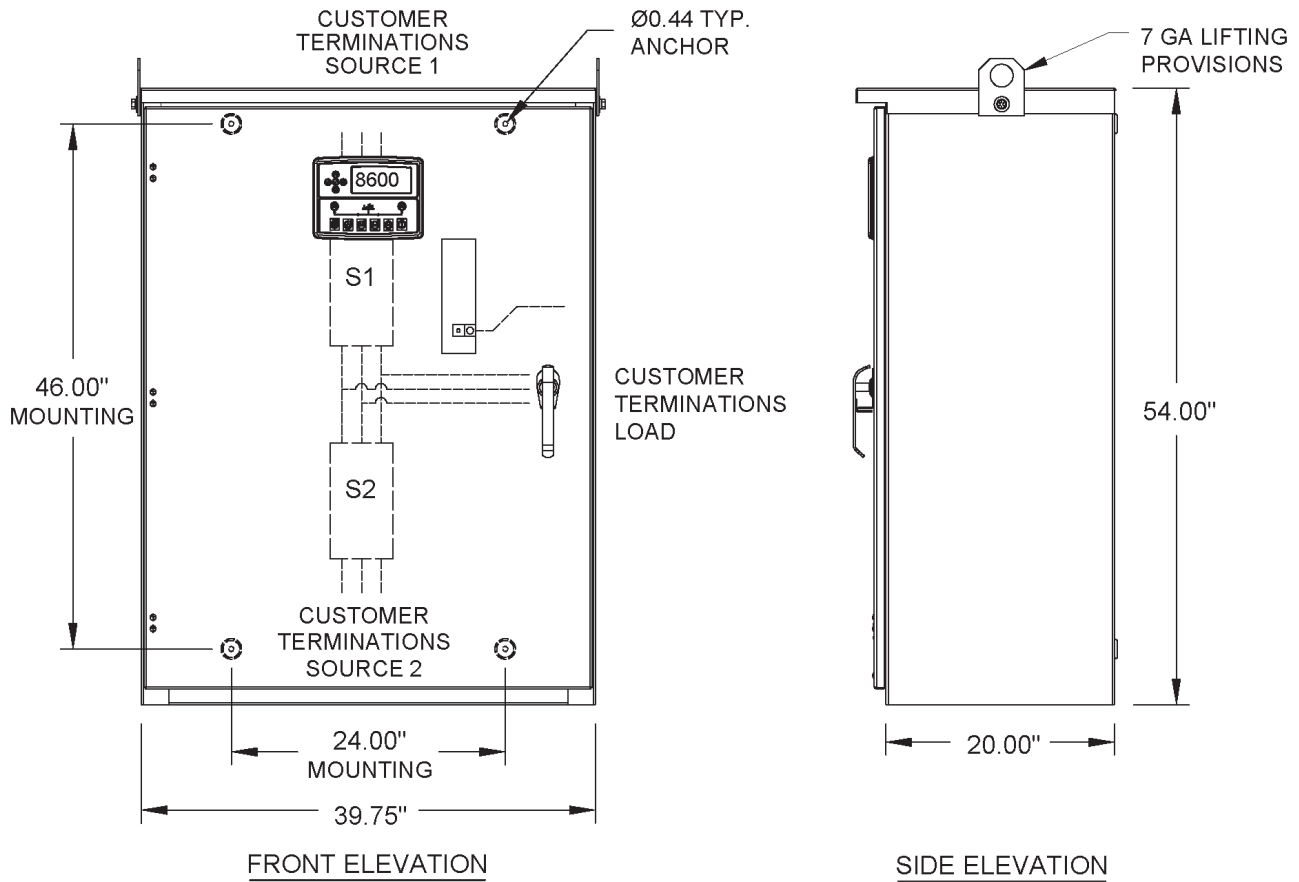

Recommended Cable Entry

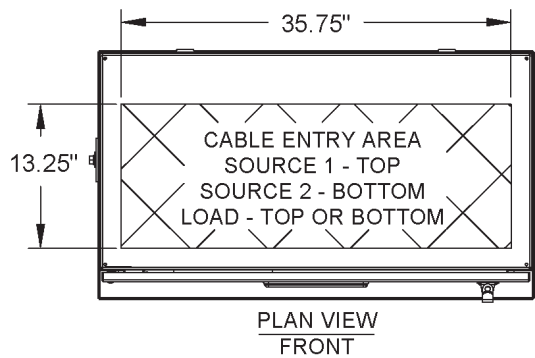

Table 33 : Enclosure Dimensions

Height	54"
Width	39.75"
Depth	20"
Approximate Weight	550 lbs.
Cable Entry Dimensions	35.75"W x 13.25"D

TRANSFER

Weights & Dimensions

AMD Transfer Switch (600A - 1200A)

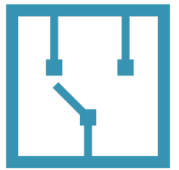

Exterior Layout & Dimensions

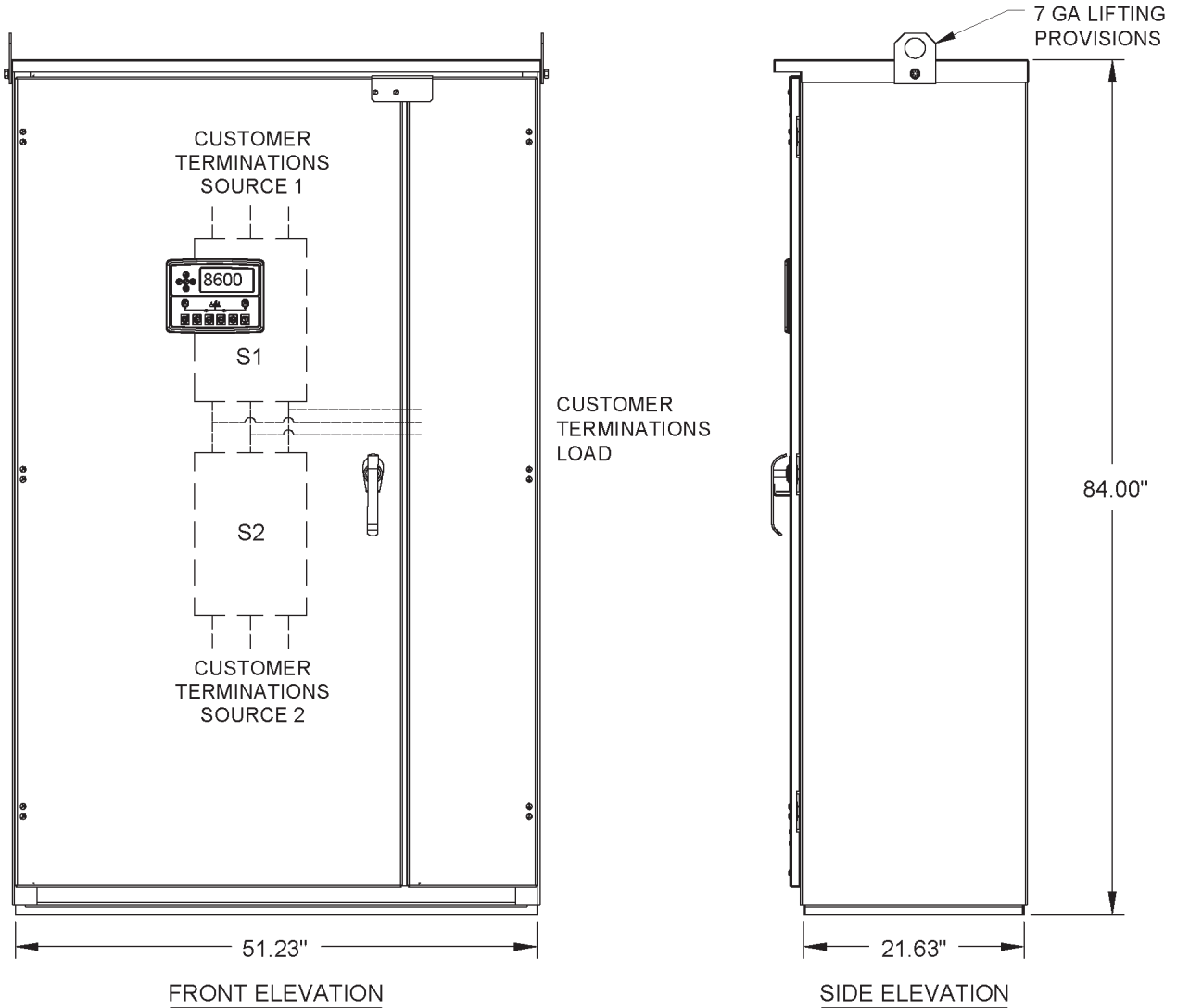

Recommended Cable Entry

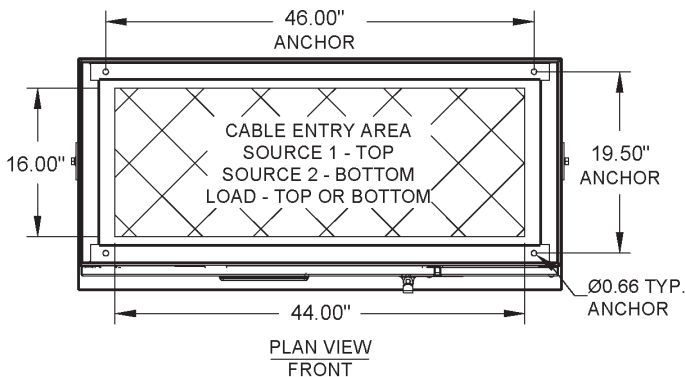

Table 34 : Enclosure Dimensions

Height	84"
Width	51.23"
Depth	21.63"
Approximate Weight	750 lbs.
Cable Entry Dimensions	44"W x 16"D

TRANSFER

Connection Information

Mechanical Lug Size & Quantity

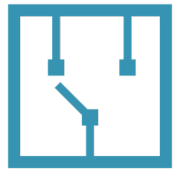
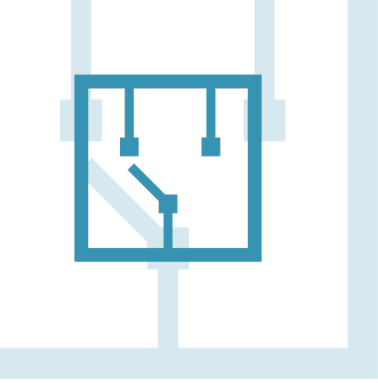

Table 35 : Lug Size & Quantity

Ampacity	Location		Standard Lug	Optional Lug	Ground
150A	Normal Source	Per Phase	(1) #14-1/0	N/A	(1) #14-1/0
		Neutral	(1) #14-1/0	N/A	
	Alternate Source	Per Phase	(1) #14-1/0	N/A	
		Neutral	(1) #14-1/0	N/A	
	Load	Per Phase	(1) #14-1/0	N/A	
		Neutral	(1) #14-1/0	N/A	
225A	Normal Source	Per Phase	(1) 2/0-500MCM or (2) 2/0-250MCM	(1) 500-750MCM	(1) #14-1/0
		Neutral	(1) 2/0-500MCM or (2) 2/0-250MCM	(1) 500-750MCM	
	Alternate Source	Per Phase	(1) 2/0-500MCM or (2) 2/0-250MCM	(1) 500-750MCM	
		Neutral	(1) 2/0-500MCM or (2) 2/0-250MCM	(1) 500-750MCM	
	Load	Per Phase	(1) 2/0-500MCM or (2) 2/0-250MCM	(1) 500-750MCM	
		Neutral	(1) 2/0-500MCM or (2) 2/0-250MCM	(1) 500-750MCM	
400A	Normal Source	Per Phase	(1) 2/0-500MCM or (2) 2/0-250MCM	(1) 500-750MCM	(1) #14-1/0
		Neutral	(1) 2/0-500MCM or (2) 2/0-250MCM	(1) 500-750MCM	
	Alternate Source	Per Phase	(1) 2/0-500MCM or (2) 2/0-250MCM	(1) 500-750MCM	
		Neutral	(1) 2/0-500MCM or (2) 2/0-250MCM	(1) 500-750MCM	
	Load	Per Phase	(1) 2/0-500MCM or (2) 2/0-250MCM	(1) 500-750MCM	
		Neutral	(1) 2/0-500MCM or (2) 2/0-250MCM	(1) 500-750MCM	
600A	Normal Source	Per Phase	(2) 400-500 MCM	N/A	(1) #14-1/0
		Neutral	(2) 400-500 MCM	N/A	
	Alternate Source	Per Phase	(2) 400-500 MCM	N/A	
		Neutral	(2) 400-500 MCM	N/A	
	Load	Per Phase	(2) 250 - 500 MCM	N/A	
		Neutral	2) 250 - 500 MCM	N/A	
800A	Normal Source	Per Phase	(3) 500-750 MCM	(4) 4/0-500MCM	(1) #6-350MCM
		Neutral	(3) 500-750 MCM	(4) 4/0-500MCM	
	Alternate Source	Per Phase	(3) 500-750 MCM	(4) 4/0-500MCM	
		Neutral	(3) 500-750 MCM	(4) 4/0-500MCM	
	Load	Per Phase	(3) 500-750 MCM	(4) 4/0-500MCM	
		Neutral	(3) 500-750 MCM	(4) 4/0-500MCM	
1200A	Normal Source	Per Phase	(3) 500-750 MCM	(4) 4/0-500MCM	(1) #6-350MCM
		Neutral	(3) 500-750 MCM	(4) 4/0-500MCM	
	Alternate Source	Per Phase	(3) 500-750 MCM	(4) 4/0-500MCM	
		Neutral	(3) 500-750 MCM	(4) 4/0-500MCM	
	Load	Per Phase	(3) 500-750 MCM	(4) 4/0-500MCM	
		Neutral	(3) 500-750 MCM	(4) 4/0-500MCM	



LSE

LAKE SHORE

ELECTRIC

The information contained in this document is for general information purposes only. While Lake Shore Electric strives to keep the information up to date and correct, it makes no representations or warranties of any kind, express or implied, about the completeness, accuracy, reliability, suitability, or availability with respect to the information, products, services, or related graphics contained in the document for any purpose. Any reliance placed on such information is therefore strictly at your own risk. Lake Shore Electric reserves the right to discontinue any product or service at any time.

Global Headquarters:

Lake Shore Electric, LLC.
5 Hemisphere Way
Bedford, OH 44146

Contact Information:

Phone: 440.232.0200
E-Mail: Sales@lake-shore-electric.com
www.lake-shore-electric.com/transfer