

# UTILITY TRANSFORMER METERING CABINET

## 400-800 AMP, 600VAC, TYPE 3R

### APPLICATION

Lake Shore Electric's First Energy approved utility transformer metering cabinet provides Type 3R protection and includes factory installed bus for utility provided 400-800 amp metering equipment.



### Industry Standard:

UL 414 Listed; Type 3R  
File No. E240038



### FEATURES

- Overlapping double-door with 3-point latch and stainless steel lift-off hinges
- Stainless steel handle with padlock provisions
- Door stop
- Window-type or bar-type current transformer
- Removable copper bus links
- Neutral pad with mechanical lugs
- Dual rated (Cu/Al) 600kcmil mechanical lugs
- Drip-shield top and seam-free sides and back
- No gasketing or knockouts
- Ground Lug
- Ground stud provided, 1/2 in. diameter

### PRODUCT SPECIFICATION

Utility Co.	Installation	Electrical Specifications	Dimensions (H x W x D)	Lb	Lug Size	
					Line	Load
First Energy	Wall Mount	400-800 Amp, 50kAIC, 600V	48 x 48 x 12	315	(3) 2AWG - 600MCM Per Phase & Neutral	(3) 2AWG - 600MCM Per Phase & Neutral

### UTMC MODEL CODES

Model	Finish	Enclosure Material
UTMC-HD-484812-08M-3A-FEC-00	Gray Polyester Powder Coat; G90 Equivalent Protection	Hot Rolled Steel
UTMC-HD-484812-08M-3B-FEC-00	#4 Brushed Finish	Aluminum
UTMC-HD-484812-08M-3C-FEC-00	#4 Brushed Finish	304 Stainless Steel
UTMC-HD-484812-08M-3D-FEC-00	#4 Brushed Finish	316 Stainless Steel

### LEG KITS

Model	Finish	Leg Kit Material
UTMC-LK-484812-3A	Gray Polyester Powder Coat; G90 Equivalent Protection	Hot Rolled Steel
UTMC-LK-484812-3C	#4 Brushed Finish	304 Stainless Steel
UTMC-LK-484812-3D	#4 Brushed Finish	316 Stainless Steel

[lseenclosure.com/utmc](http://lseenclosure.com/utmc)

UTILITY TRANSFORMER METERING CABINET  
400-800 AMP, 600VAC, TYPE 3R

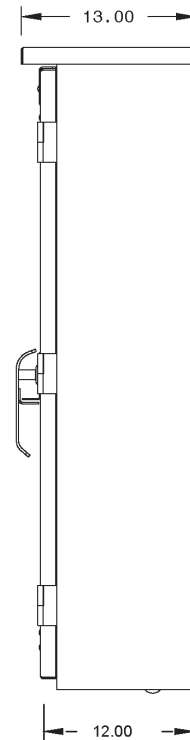
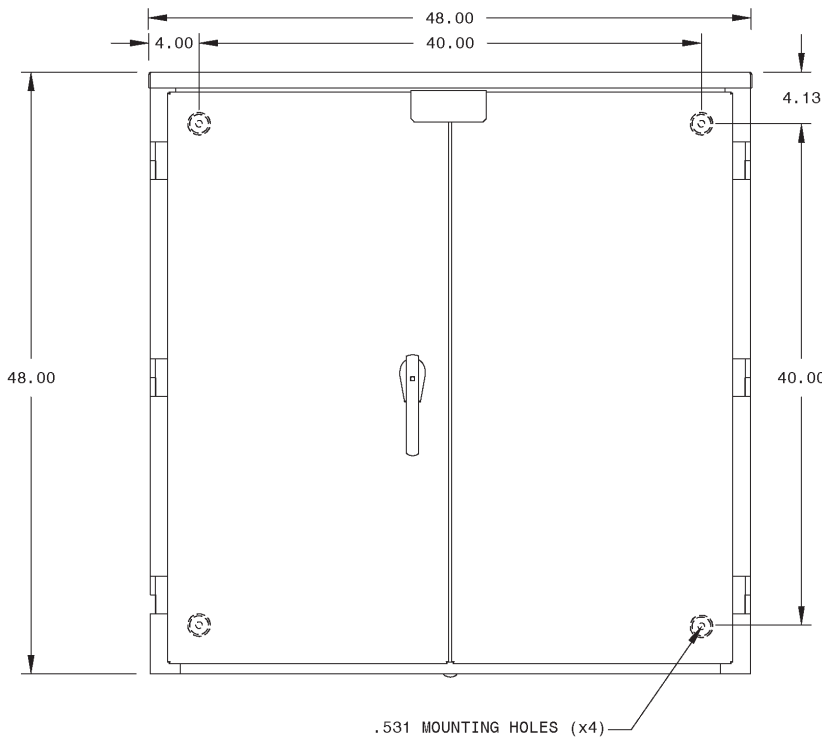
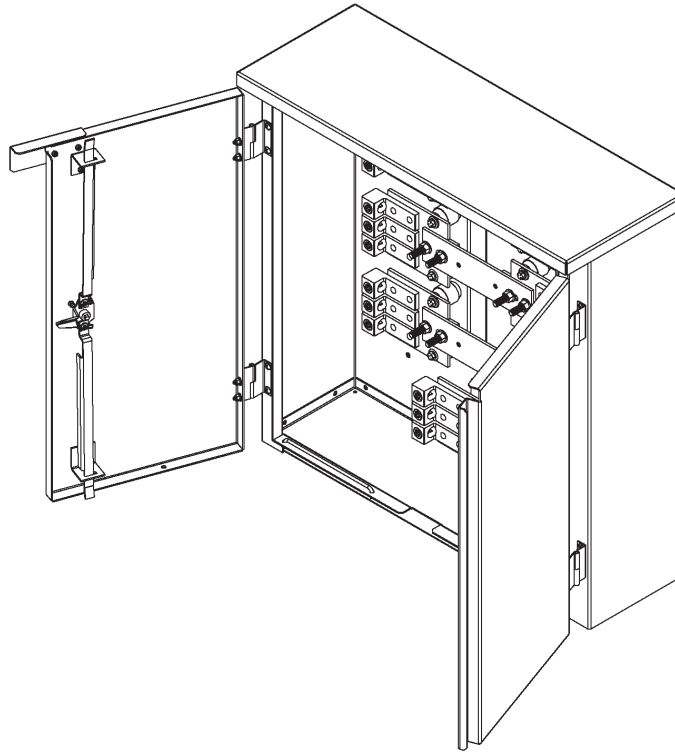

[lseenclosure.com/utmc](http://lseenclosure.com/utmc)