

UTILITY TRANSFORMER METERING CABINET

38x60x18 ENCLOSURE, 600VAC, TYPE 3R

APPLICATION

Lake Shore Electric's Duquesne Light approved utility transformer metering enclosure provides Type 3R protection for a customer supplied backplate.



Industry Standard:

UL 414 Listed; Type 3R
File No. E240038

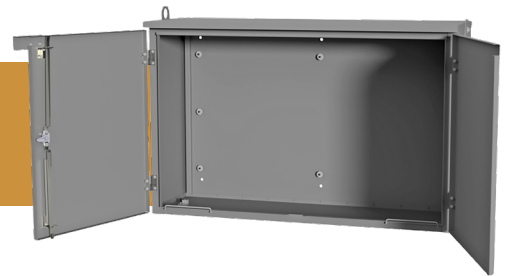

FEATURES

- Overlapping double-door with 3-point latch and stainless steel lift-off hinges
- Stainless steel handle with padlock provisions
- Door stop
- Mounting provisions for customer supplied backplate
- Drip-shield top and seam-free sides
- No gasketing or knockouts
- Ground lug provided, 2-14 AWG, single conductor

PRODUCT SPECIFICATION

Utility Co.	Installation	Electrical Specifications	Dimensions (H x W x D)	Lb	Lug Size
Duquesne Light	Wall Mount	N/A	38 x 60 x 18	288	N/A

UTMC MODEL CODES

Model	Finish	Enclosure Material
UTMC-HD-386018-ECN-3A-DQL-00	Gray Polyester Powder Coat; G90 Equivalent Protection	Hot Rolled Steel
UTMC-HD-386018-ECN-3B-DQL-00	#4 Brushed Finish	Aluminum
UTMC-HD-386018-ECN-3C-DQL-00	#4 Brushed Finish	304 Stainless Steel
UTMC-HD-386018-ECN-3D-DQL-00	#4 Brushed Finish	316 Stainless Steel

LEG KITS

Model	Finish	Leg Kit Material
UTMC-LK-386018-3A	Gray Polyester Powder Coat; G90 Equivalent Protection	Hot Rolled Steel
UTMC-LK-386018-3C	#4 Brushed Finish	304 Stainless Steel
UTMC-LK-386018-3D	#4 Brushed Finish	316 Stainless Steel

lseenclousure.com/utmc

UTILITY TRANSFORMER METERING CABINET
38x60x18 ENCLOSURE, 600VAC, TYPE 3R

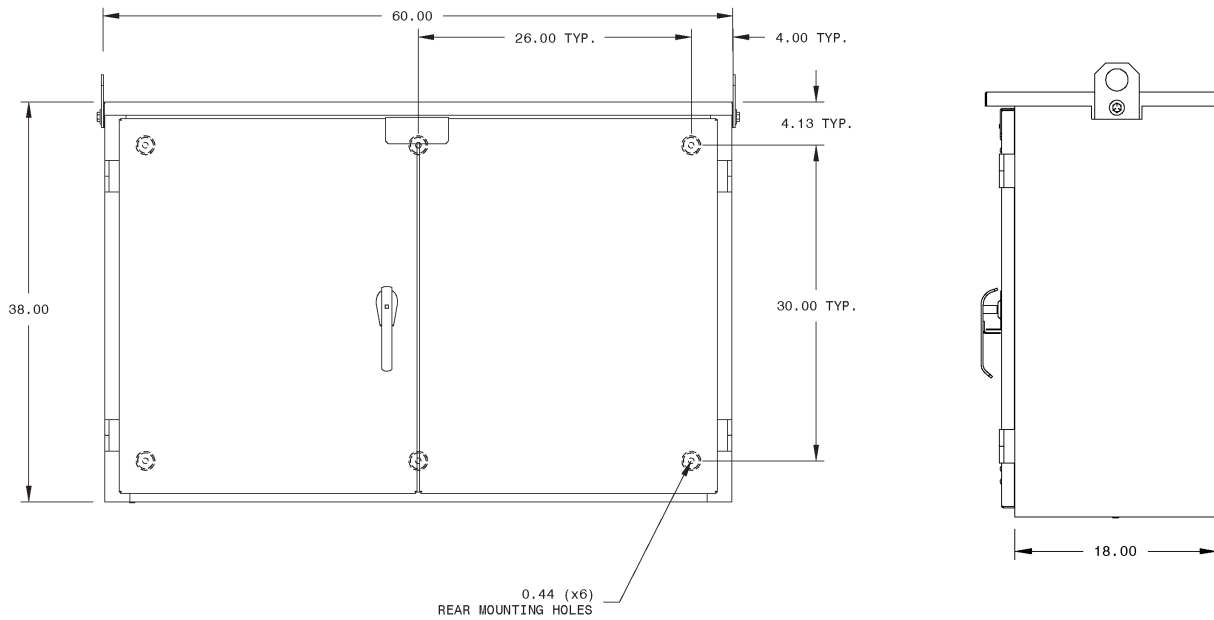
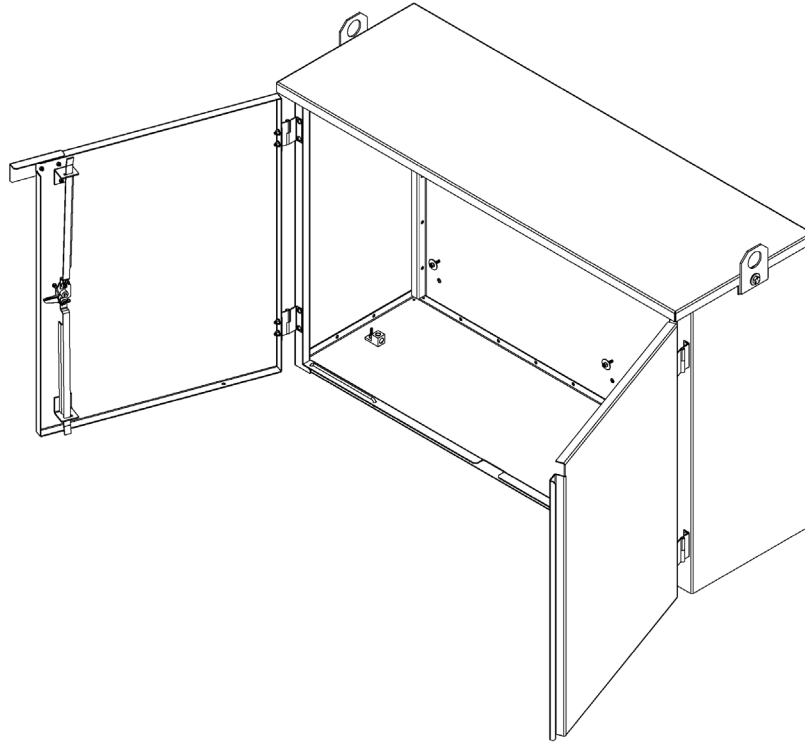

lseenclosure.com/utmc