

UTILITY TRANSFORMER METERING CABINET

1600-2000 AMP, 600VAC, TYPE 3R



FEATURES

- Overlapping double-door with 3-point latch and stainless steel lift-off hinges
- Stainless steel handle with padlock provisions
- Door stop
- Window-type or bar-type current transformer
- Removable copper bus links
- Neutral pad with mechanical lugs
- Dual rated (Cu/Al) 600kcmil mechanical lugs
- Drip-shield top and seam-free sides
- No gasketing or knockouts
- Removable gland plate
- Ground stud provided, 1/2 in. diameter

APPLICATION

Lake Shore Electric's First Energy approved utility transformer metering cabinet provides Type 3R protection and includes factory installed bus for utility provided 1600-2000 amp metering equipment.

Industry Standard:

UL 414 Listed; Type 3R
File No. E240038



PRODUCT SPECIFICATION

Utility Co.	Installation	Electrical Specifications	Dimensions (H x W x D)	Lb	Lug Size	
					Line	Load
First Energy	Pad Mount	1600-2000 Amp, 50kAIC, 600V	84 x 52 x 24	785	(8) 1/0 - 750MCM Per Phase & Neutral	(8) 1/0 - 750MCM Per Phase & Neutral

UTMC MODEL CODES

Model	Finish	Enclosure Material
UTMC-HD-855424-20M-3A-FEC-00	Gray Polyester Powder Coat; G90 Equivalent Protection	Hot Rolled Steel
UTMC-HD-855424-20M-3B-FEC-00	Mill Finish	Aluminum
UTMC-HD-855424-20M-3C-FEC-00	Mill Finish	304 Stainless Steel
UTMC-HD-855424-20M-3D-FEC-00	Mill Finish	316 Stainless Steel

[isecontrol.com/utmc](https://www.isecontrol.com/utmc)



UTILITY TRANSFORMER METERING CABINET

1600-2000 AMP, 600VAC, TYPE 3R

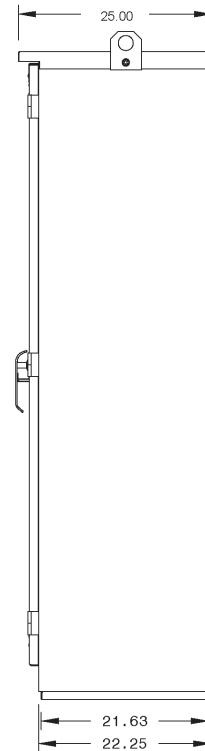
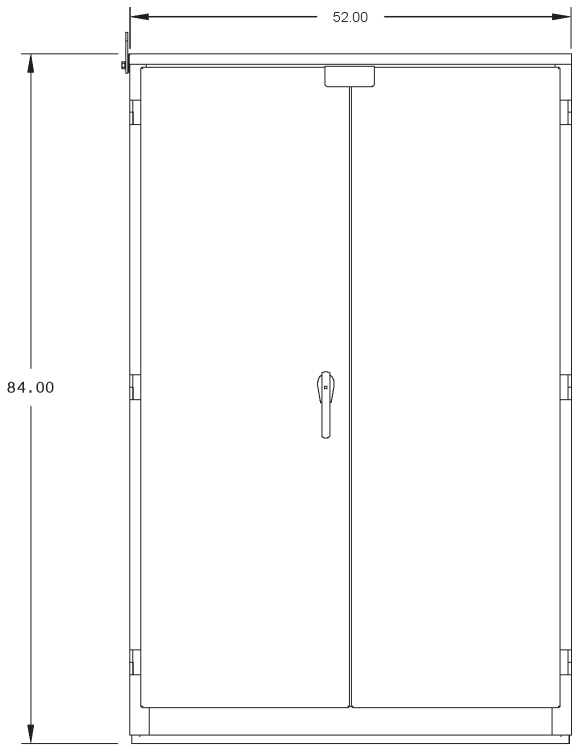
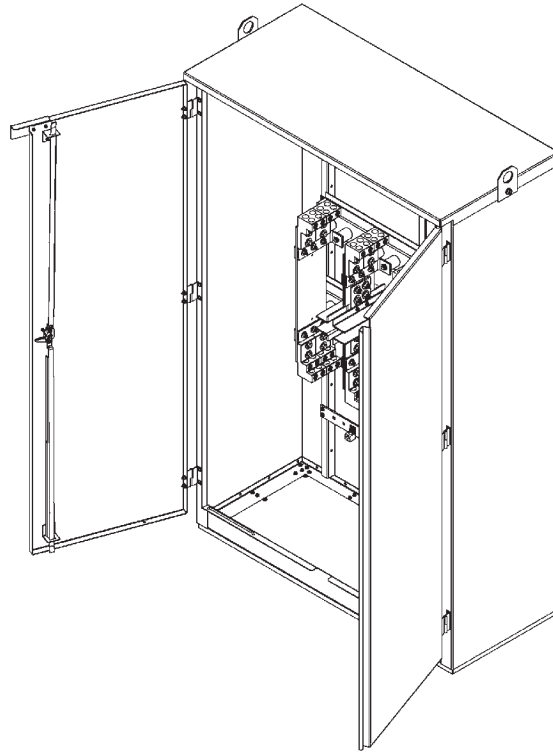

lsecontrol.com/utmc